

mjcp

More Juice Creative Print

Measuring for Glass Manifestation

Measuring for Glass Manifestation

To accurately measure your office space glass manifestation, you will need a suitable tape measure (most printers work in millimetres), something to record measurements and draw a diagram on (notebook/iPad), and a camera so that the designer can see the layout and important features of the glass.

Here we will run through how to take accurate measurements, and create a good diagram for the designer who will be responsible for the artwork creation.

Polite Notice

Taking accurate measurements is a very precise and time-consuming process. If the measurements aren't perfect, this can really affect the artwork at later stages, in some cases meaning a full replacement print is necessary.

If you're not 100% confident, please contact us and one of our experienced project managers can help you complete your survey.

MJCP cannot take responsibility for inaccurate externally made measurements. Please take great care to ensure your project goes smoothly.

01 - Draw out a rough diagram of the area being covered

To start, you should count the amount of panels in the run of glass, make a note of where doors are, and if there are any gaps in-between the panes of glass. This does not have to be accurate, but try and keep it visually to scale.

Example



This is an example Office panel layout which when complete would look something like the below. Note doors, handles, and where there are metal fixtures. Take care to note where gaps are between panels.

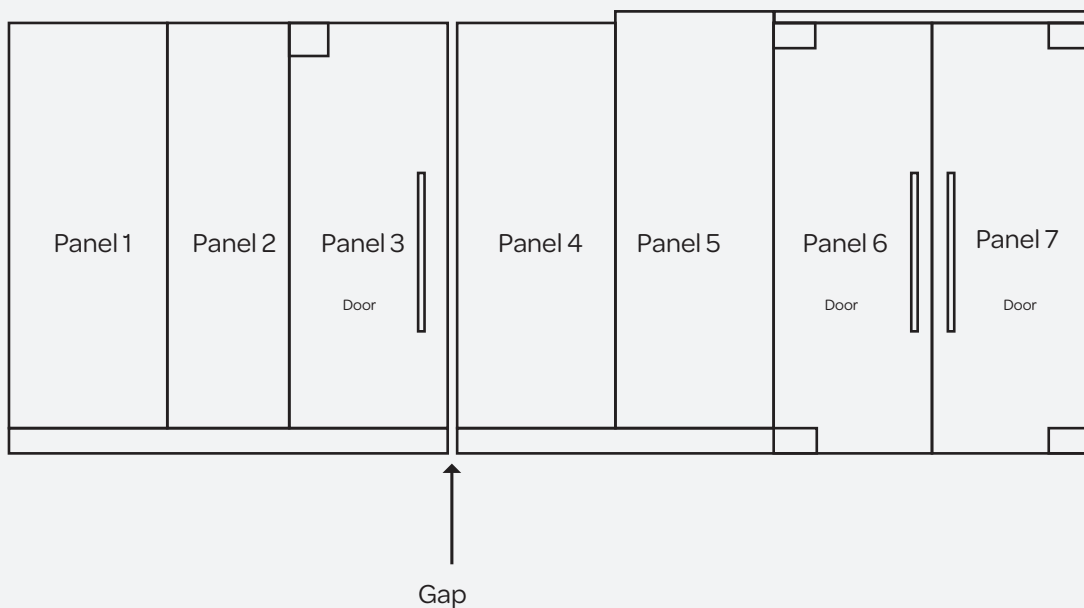

02 - Take overall height measurements

The first thing you need is an overall height of the window. You can include the any skirting or metal runners in the measurement, we just need to know the floor to ceiling. We advise you measure each panel. Hopefully they will all be the same height, but if not, make a note to make it clear there is a height difference in panels.



— = Measuring guide

Example with sizes added in red below

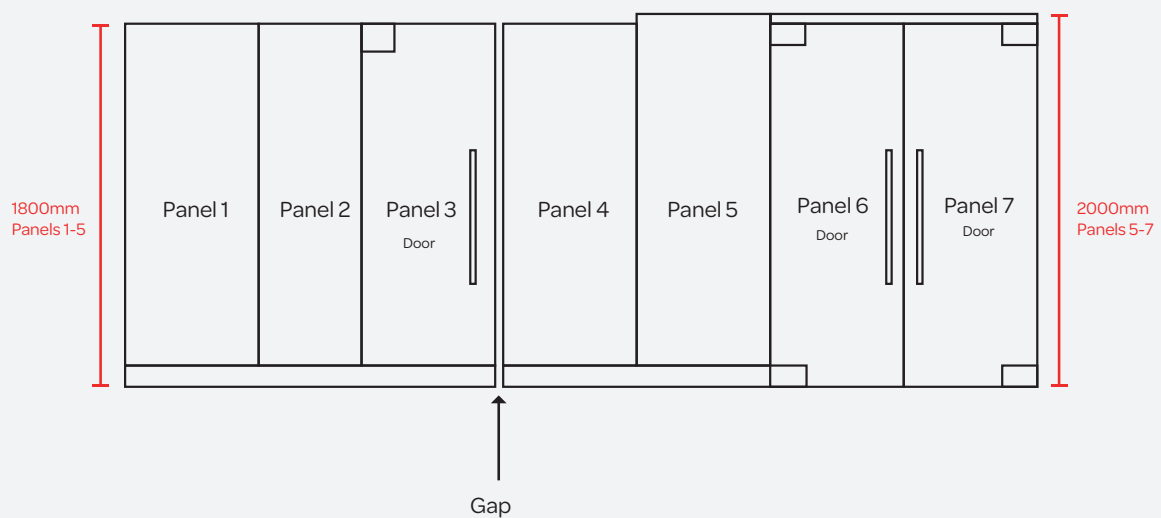

03 - Take overall width measurement

The second is overall width. You may need an extra pair of hands with this. Take at least two horizontal measurements, and *make sure the tape measure is level with the ground.*

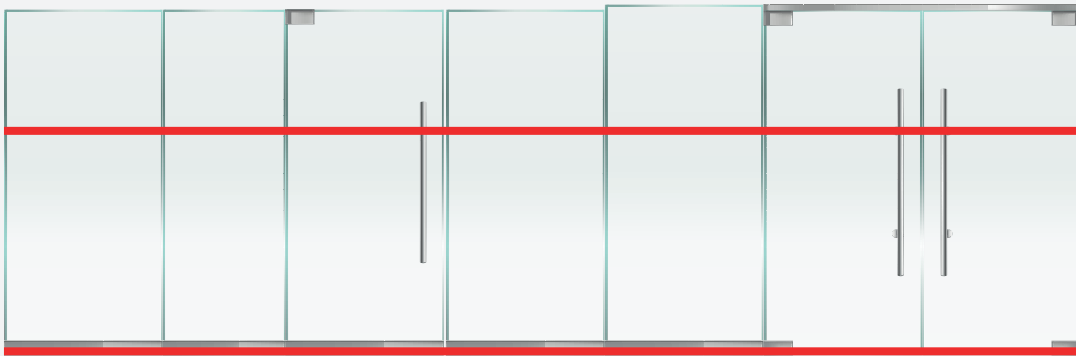

— = Measuring guide

Example with sizes added below

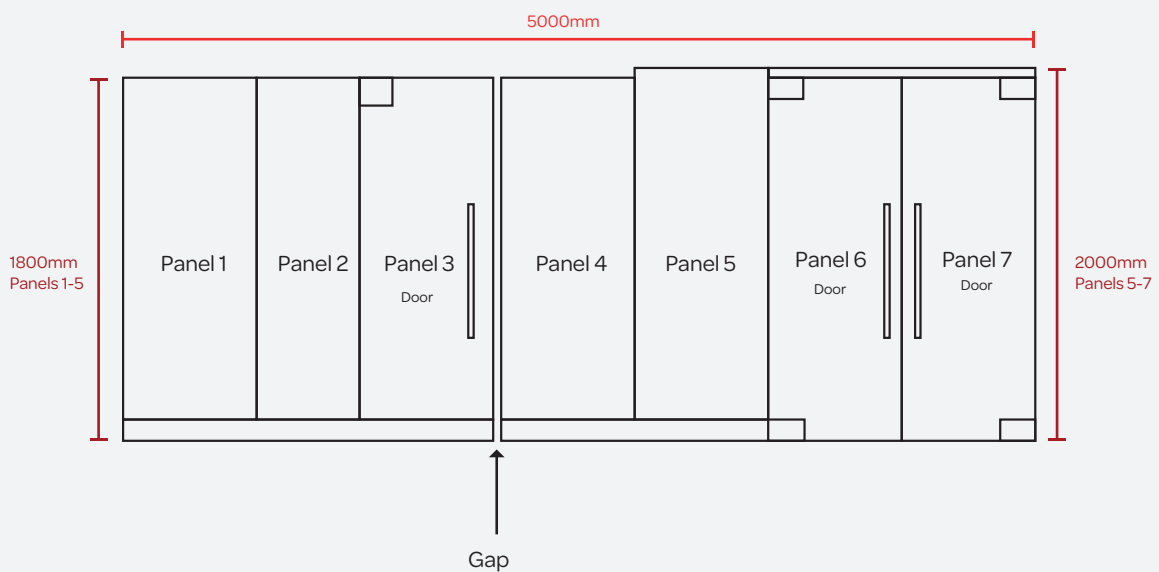

04 - Individual measurements

Now you have the overall size of your working area, we have to take measurements of the widths of each individual panel. This should be a little easier, as you will be able to work solo if you have to. Again, take at least two measurements for each panel so as to avoid mistakes. *Make sure the tape measure is level with the ground.*

Remember to measure any gaps

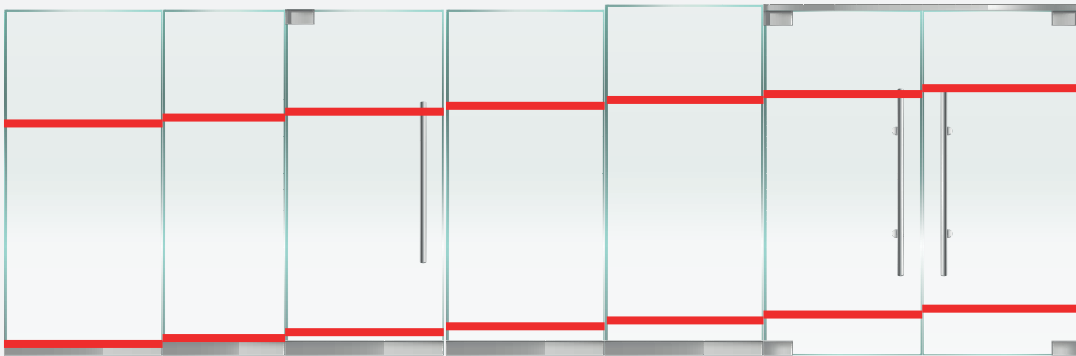

— = Measuring guide

Example with sizes added below. Individuals should add up to the overall size

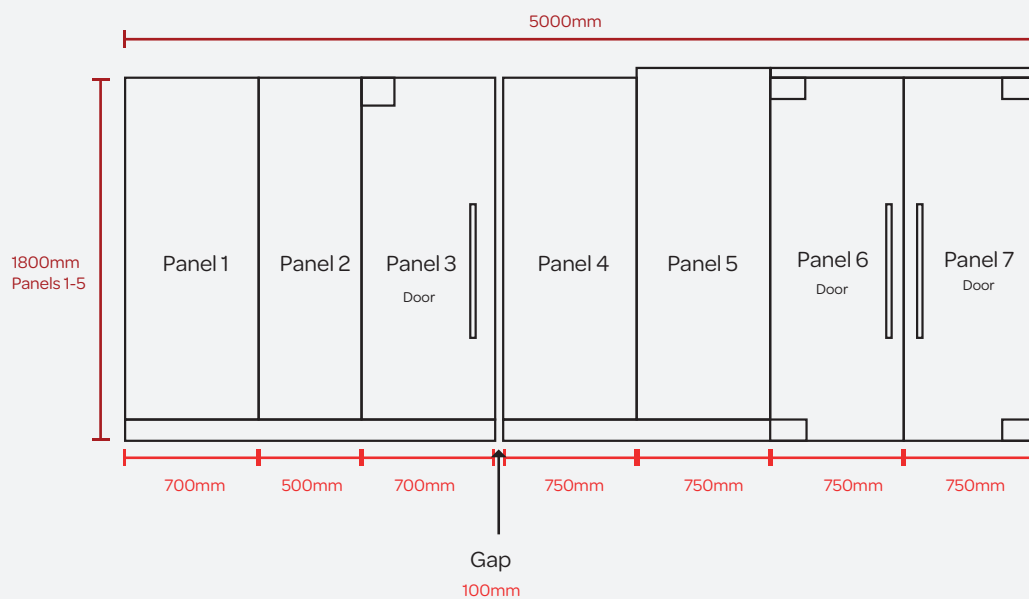

05 - Measuring placement of fixtures and fittings

Finally we move on to the most fiddly part. We need to measure where the fixtures and fittings are on the glass. Examples include handles, existing signage that you are keeping, any hinges, and skirting.

There are a few ways to do this, but for this guide we will be looking at the safest and easiest way to get accurate measurements. We will focus on one section.

Measure height and width of fitting

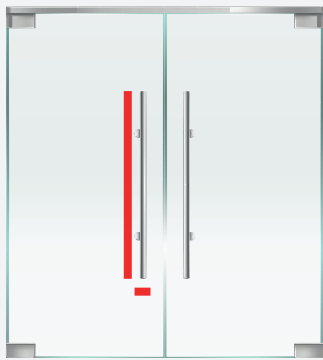

Measure placement of fitting

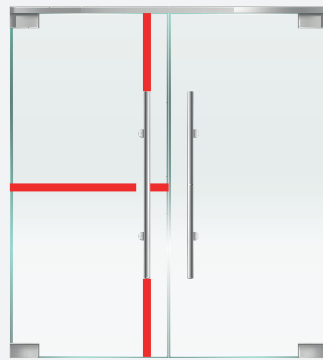

Repeat with all fittings

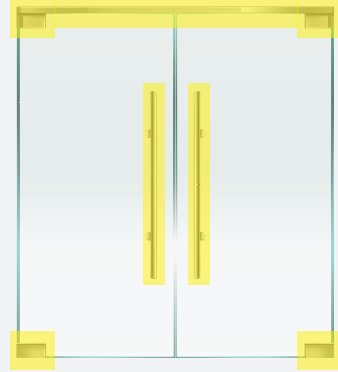

— = Measuring guide

■ = Fittings to measure

Make a separate drawing if you have no room, label the panel, and write in the measurements. Notes will also suffice.

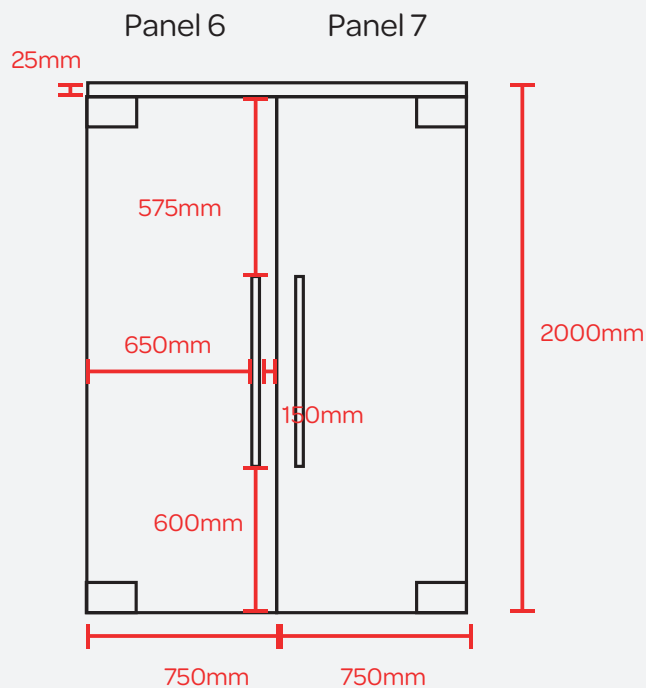

Notes

Handle is 20mm x 800mm
All corner fittings are
150mm x 100mm